

SIMPLE DIPOLE ANTENNAS

TECH DAY – OCTOBER 29, 2022

LARRY KRAL NOAMP

Basic Dipole Design

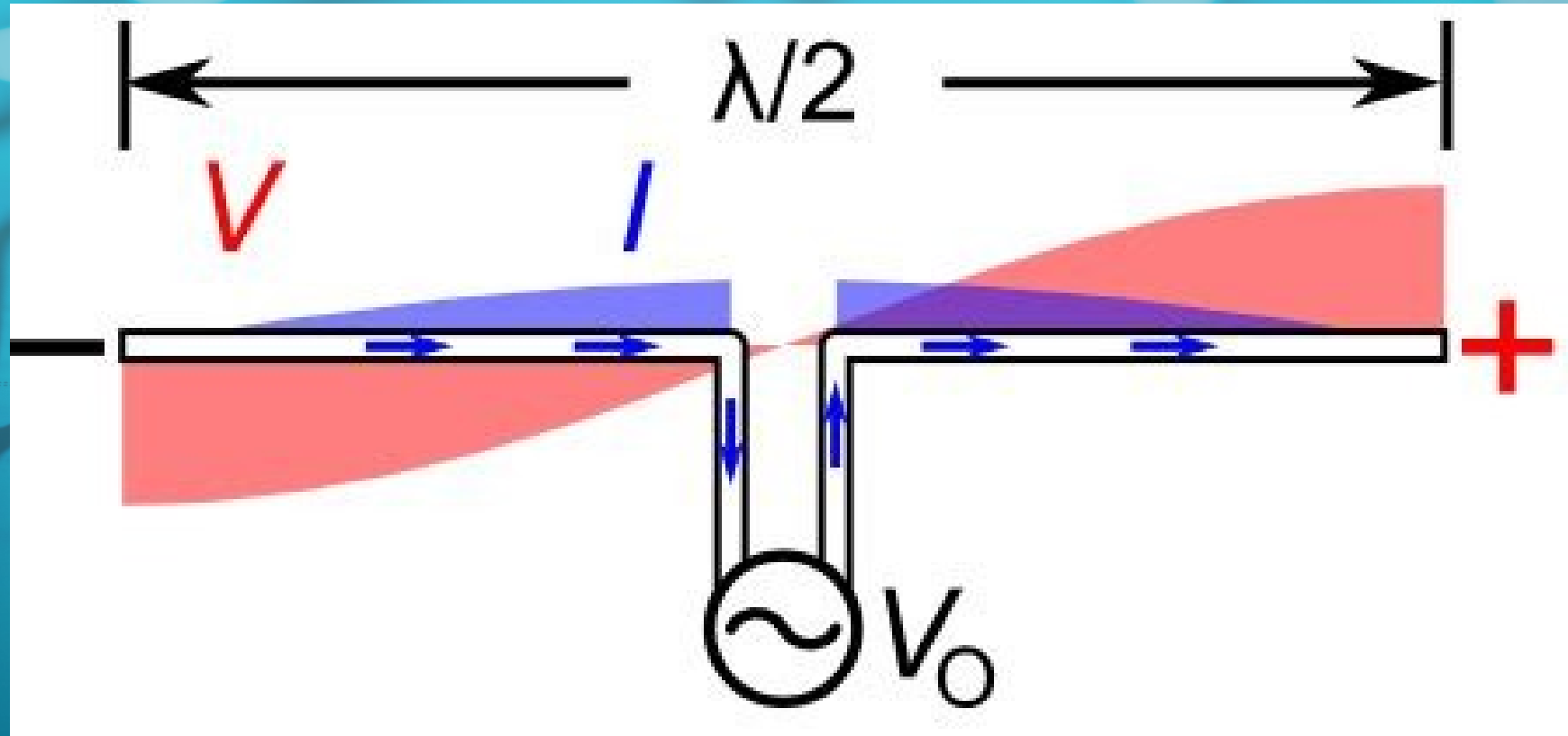

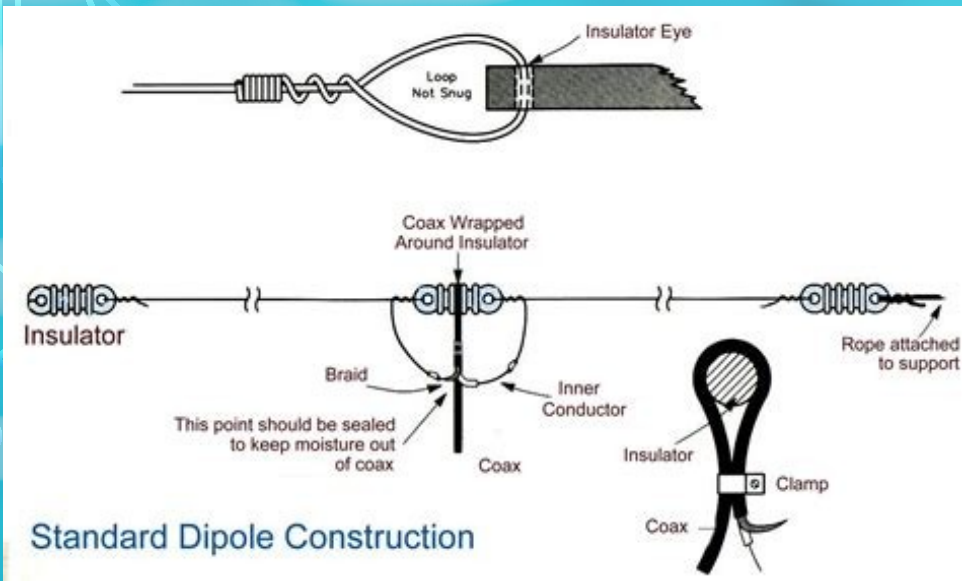

Horizontal Configured Dipole

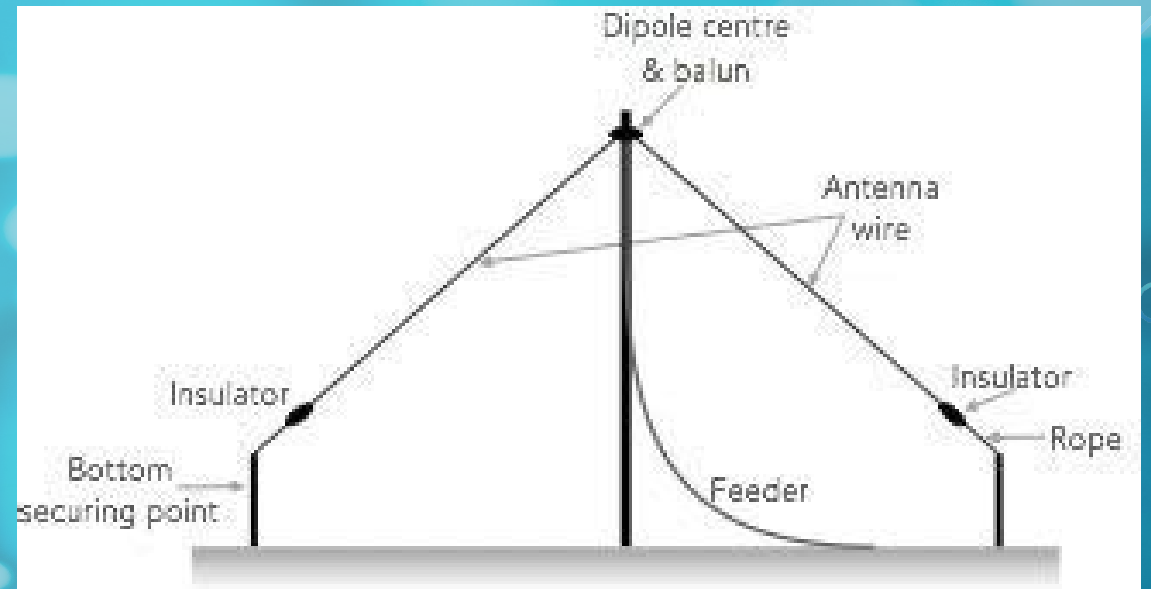

Inverted-V Configuration

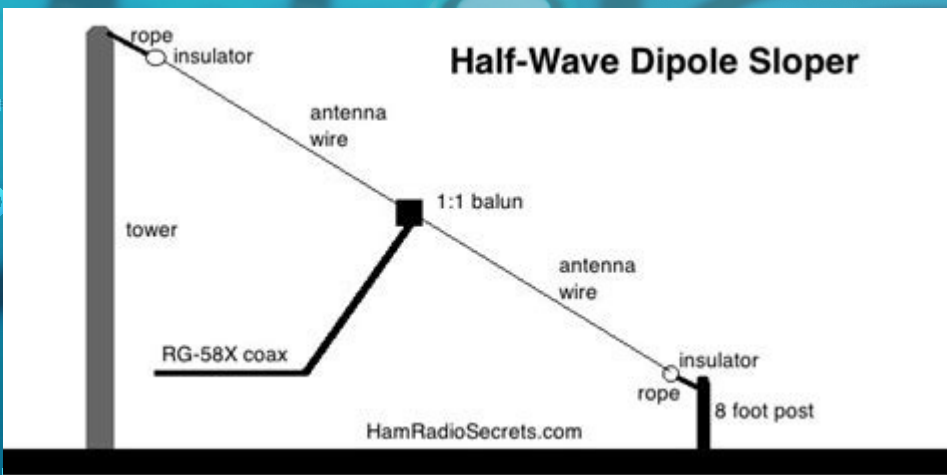

Sloping Dipole Configuration



Fan Dipole

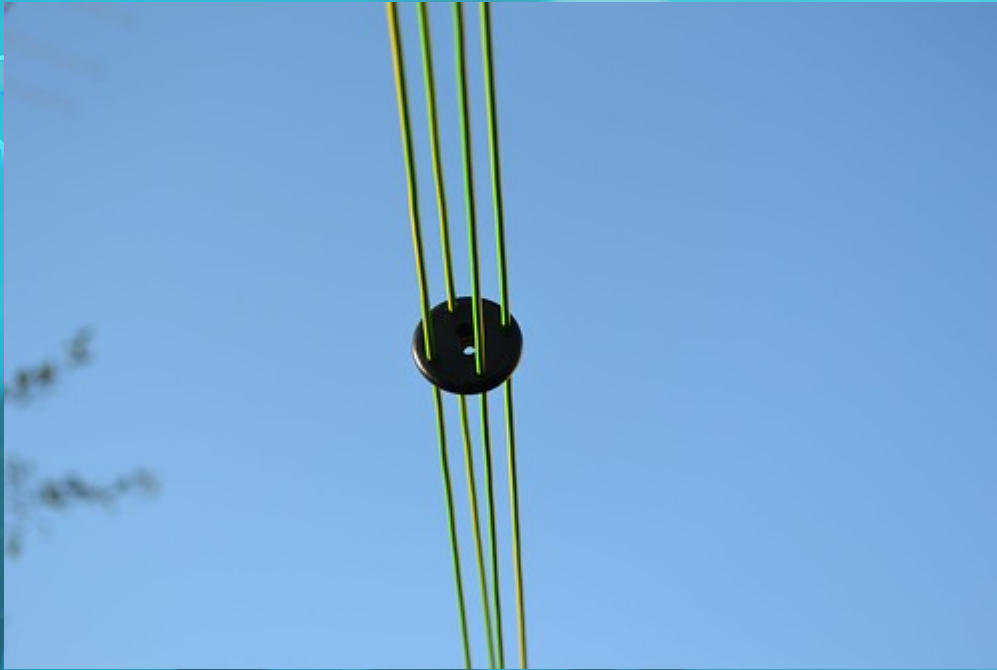

Cage Dipole

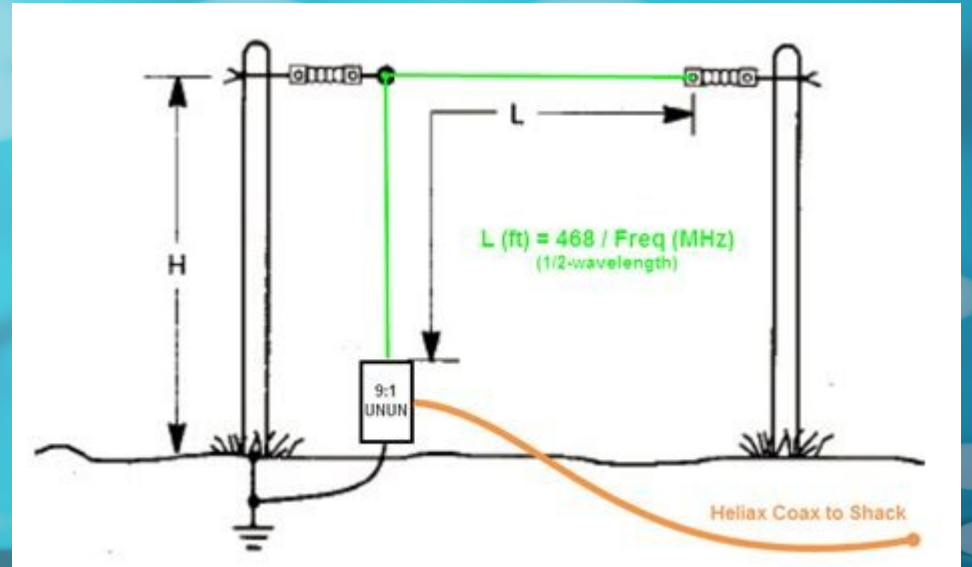

Inverted L Antenna

Wire Considerations

Copper – Soft Drawn (THHN)

Copper Hard Drawn

Copper Clad Steel (CCS Copperweld)

Stranded Copper

Gauge (larger gauge broader band width)

Insulated Wire changes velocity factor

Insulators (Egg vs DogBone)

CALCULATING LENGTH OF ANTENNA

Wire length depends on the desired band

Start with length $490/\text{frequency}$ – trim later

Use this formula to calculate how to adjust the length

$$l_2 = l_1 * f_2 / f_1$$

l_1 original length l_2 new length

f_1 original frequency f_2 measured frequency

ANTENNA MEASUREMENTS

ANTENNA ANALYZER MFJ-269

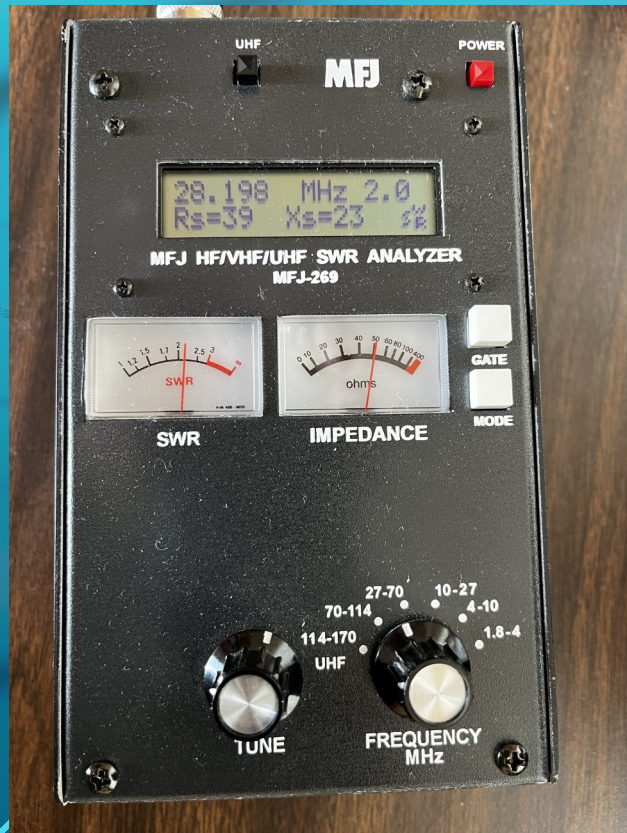

Need for a BALUN

Keeps RF from getting back into shack

Commercial BALUN

Commercial BALUNs

Kit Built BALUNs

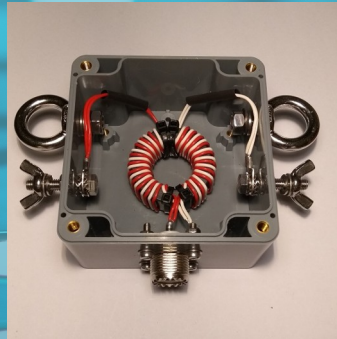

Home Brew – Ugly BALUN



Antenna Feedlines

Ladder Line

Needs to be in free space

Coax

Can be run anywhere

Coax Type

Power to be used

Frequency to Be used

Length of run

Coaxial cable understanding the differences

The background is a vibrant blue with a complex pattern of white and light blue lines and dots, resembling a circuit board or a data network. The lines are thick and wavy, while the dots are arranged in a grid-like pattern. The overall aesthetic is clean, modern, and technological.

Questions

Some Simple End Fed Wire HF Antennas

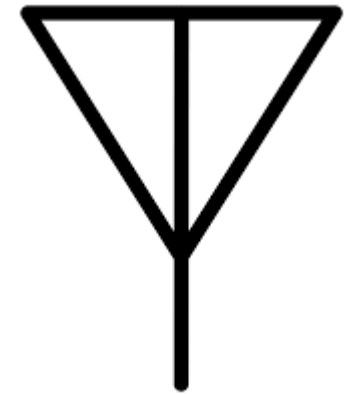

General thoughts on wire antennas

- With wire antennas consider both electrical properties and physical
- Wire that may touch the ground or anything conductive should be insulated
- Wire that is isolated from anything conductive may be bare
- Heavier gauge is better if there will be wind, snow or ice loads
- Wire gauge and material will affect the resonant length
- Some materials will stretch more than others
- Wire types and gauges highlight that electrical performance is at odds with physical advantages.
- Lighter gauge will have a higher Q and will be less broadbanded than heavier gauge wire antennas

Key Take-Aways for Antennas:

- Any conductor will work as an antenna at any frequency
- Objective is to build an antenna that radiates more than it converts the signal into heat.
- The total amount of energy radiated is constant based on output power, but the energy can be focused resulting in gain in the designed directions
- 1:1 SWR does not mean the antenna is resonant, only that impedances are matched.
- The formula for cutting the length is not precise – always cut a longer length. Each of the following affects the correct length of a wire antenna:
 - Height above ground
 - Proximity to other objects
 - Insulated or not
 - Gauge
 - Type of metal in wire
 - Braided, twisted, or solid conductor
- Anything located within $1/8$ wavelength of an antenna will affect operation:
 - Pattern distortion
 - Skewing of balance
 - Change of feed point impedance
 - Resonant frequency shift.

**Three major end fed antenna
types:**

1. End Fed Zepp (aka J-Pole)

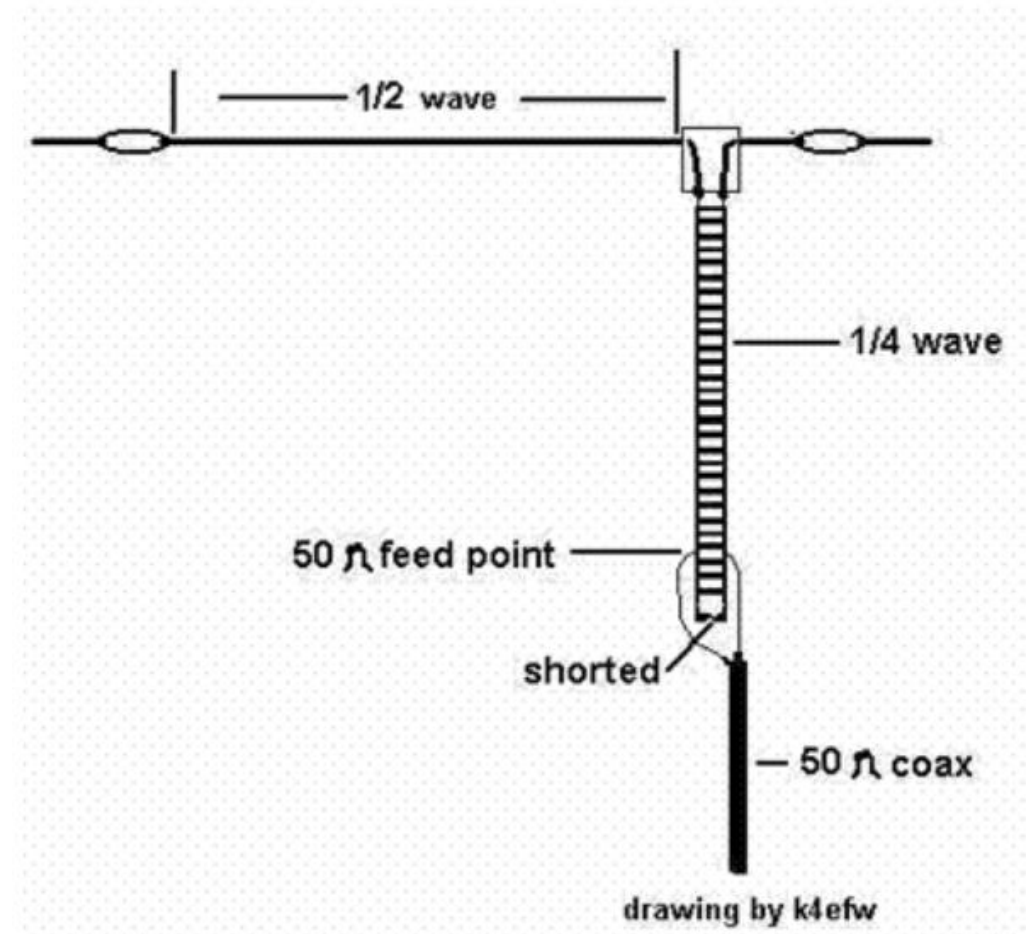

2. End Fed Half Wave (EFHW)

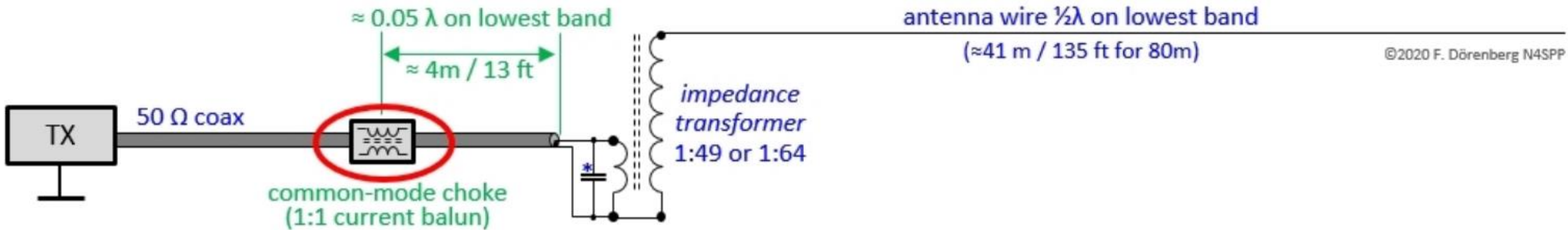

The common mode current choke is most effective if it is approximately 0.05λ away from the transformer, the same length as the counterpoise.

3. Non-Resonant End Fed

- Identical to the EFHW except:
 - the wire length should not make it resonant on the fundamental frequency or any harmonic
 - The UNUN is 9:1



An end fed antenna is really an off center fed antenna

- Remember Kirchhoff's Current Law:
 - The total current entering a junction or node equals the current leaving the junction or node
- This means that the current flowing into the end fed antenna has to be returned. This can happen through a suitable counterpoise or by flowing back down the feedline (if that is part of the design, but if so, you will want to block that flow at some point with a choke)
- Without this return current it would be impossible to apply power to the antenna.

End Fed Half Wave (Zebp)

- Half wave of wire fed with matched feedline (e.g., ladder line) $\frac{1}{4}$ wavelength long that is in turn connected to coax
- This can be low loss as a result of the feedline
- Typically need to be high
- Needs a feedline choke at the point where the coax meets the ladderline

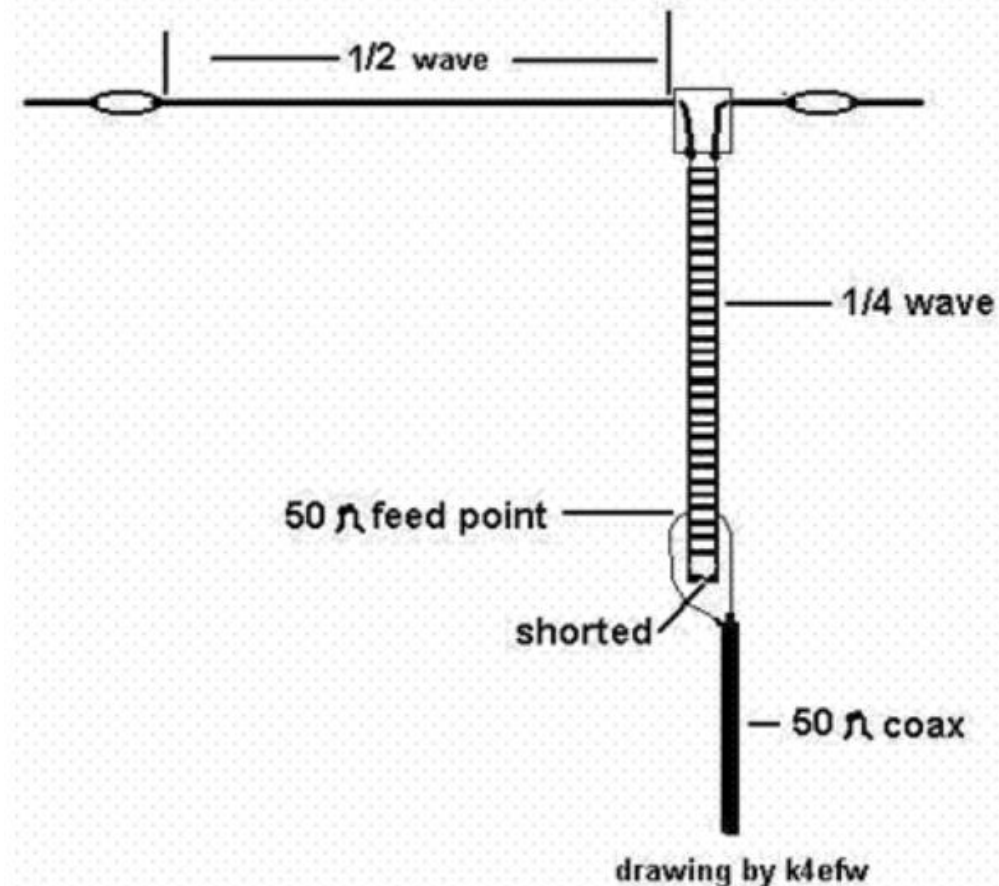

End Fed Half Wave

- Works on the fundamental frequency
 - Works on harmonics of the fundamental frequency without a tuner, other frequencies are possible with a tuner
 - Tends to work better if cut for the lower end of the low bands but if cut for the lower band, it may end up out of band for the higher even harmonics – unless you use a tuner.
 - This may be addressed by changing the impedance coil inductance to adjust the resonant frequency of the lower bands (the coil has less impact on the higher frequencies)
 - Frequently works best with a tuner
- It is a voltage-fed antenna.
- Needs a matching unit transformer somewhere between 49:1 and 64:1
- Needs a feedline choke near the feed point usually at least 18” – 24” away from the feedpoint
- There are high voltages at the feed point (1-5 KV) – so be careful. Protect yourself, your surroundings, and others)
- Transformer gets hot – especially if you try to use this for the WARC bands
- To improve your results, use a good antenna tuner really an impedance matching device

An end fed half wave antenna has high input impedance

- Impedance transformers (an UNUN) are needed to match the input impedance of an EFHW.
- Typical antenna input impedance is 1800 Ω to 3600 Ω (note center fed half wave impedance is 35 Ω to 72 Ω , depending on height above earth for and EFHW the end impedance is 1800 Ω to 3600 Ω , depending on height above earth).

Use a 49:1 Transformer for an EFHW

A 49:1 UNUN, 1800 Ω is transformed to 36 Ω (SWR of 1.3:1) and 3600 Ω is transformed to about 72 Ω (SWR of 1.5:1), each should be easily matched by the internal antenna tuner/match of most modern rigs (note 2450 Ω transforms to 50 Ω)

Watch the voltage handling characteristics. If you plan to build your own consider using FT240-43 (Ferrite Toroid, 2.4" outer diameter, mix 43).



Non-Resonant End Fed

- Can be shorter than an EFHW
- Easier to deploy
- Wide bandwidth
- Needs a tuner
- The coax will radiate if a counterpoise or ground is not used
- Lower voltages are involved and works great as a multiband antenna. It is a current fed, not voltage fed antenna.
- It will only have 400 Ω to 500 Ω impedance at the feedpoint so a 9:1 transformer will work just fine.

Non-Resonant End Fed specifics:

- Want to be sure that it is not $\frac{1}{4}$ wavelength on any frequency (or harmonic) in the ham bands. Best lengths that work for non-resonant long wire antennas: 29', 35.5', 41', 58', 71', 84', 107', 119', 148', 203', 347', 407', and 423'.
- Impedance at the feed point is lower (i.e., 450 Ω) than for an EFHW since it is designed to not be resonant on any frequency of operation. It will work with a 9:1 UNUN transformer.
- The higher the frequency and longer the wire, the more directional it becomes - more off the end than broadside
- Needs a good ground or counterpoise.
- Remember to experiment with different lengths of grounds/counterpoises

Minimum wire lengths for non-resonant EF

Suggested wire lengths for 1-31 MHz operation (measured from Bullet antenna wire terminal):

Bands Covered (meters)	Wire Length (feet)	Minimum Coax Length (feet)
40-30-20-15	35-43, 49-63, 70-85	35
40-30-20-17	35-45, 54-64, 67-77	35
80-40-30-20-17-15-12-10	38-44, 55, 60, 68-73	50
80-60-40-30-20-17-15-12-10	55, 68-73, 85, 92, 102, 120-125	65
160-80-40-30-20-17-15-12-10	135, 141, 173, 203	130

Antenna Modeling

EFHW

Model Data by Harmonic

The following data are for the far field radiation patterns and 3D color views of a straight End Fed Half Wave antenna at 40 feet over "Real ground".

The direction of radiation is the Blue trace on the polar graphs. Horizontal is 90° . Up is 0° . Red color indicates the stronger radiation on 3D views.

80m	Fundamental	40m	2nd Harmonic	30m	3rd Harmonic
1 lobe	6.06 dBi at 0°	2 lobes	6.12 dBi at 50°	3 lobes	7.37 dBi at 60°

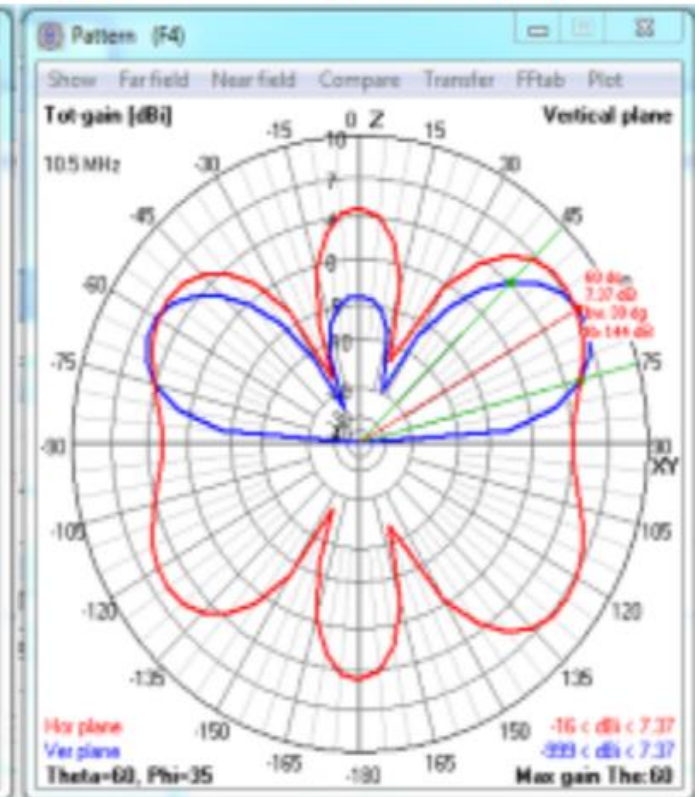
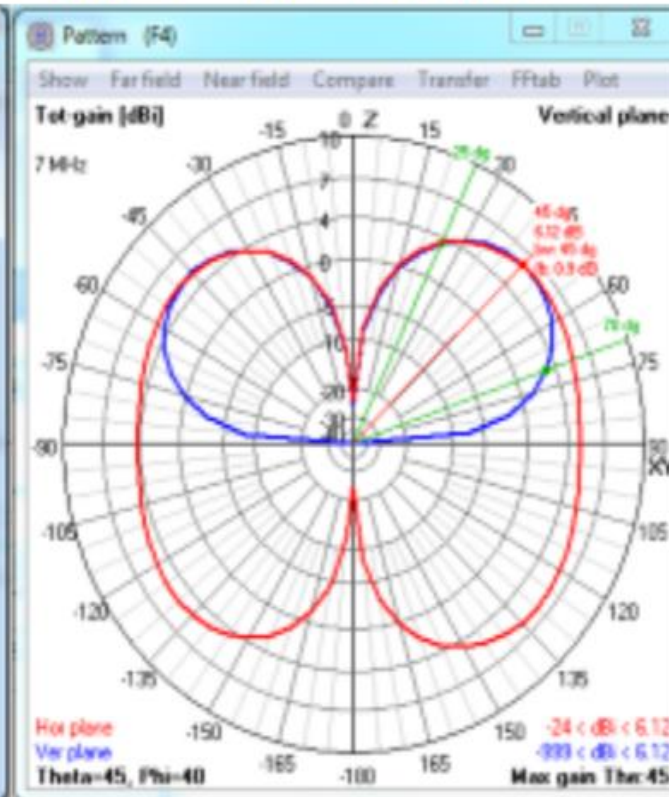
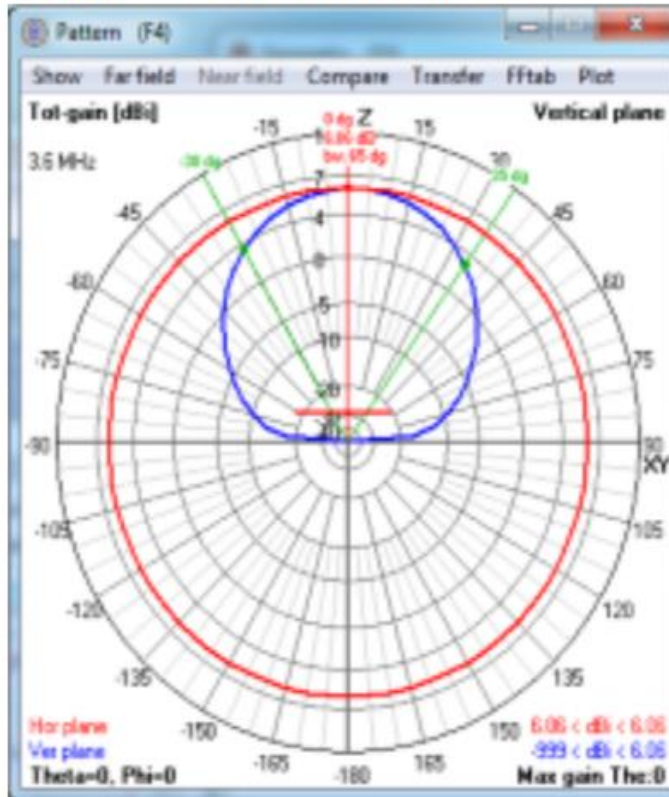

80m Fundamental
1 lobe 6.06 dBi at 0°

40m 2nd Harmonic
2 lobes 6.12 dBi at 50°

30m 3rd Harmonic
3 lobes 7.37 dBi at 60°

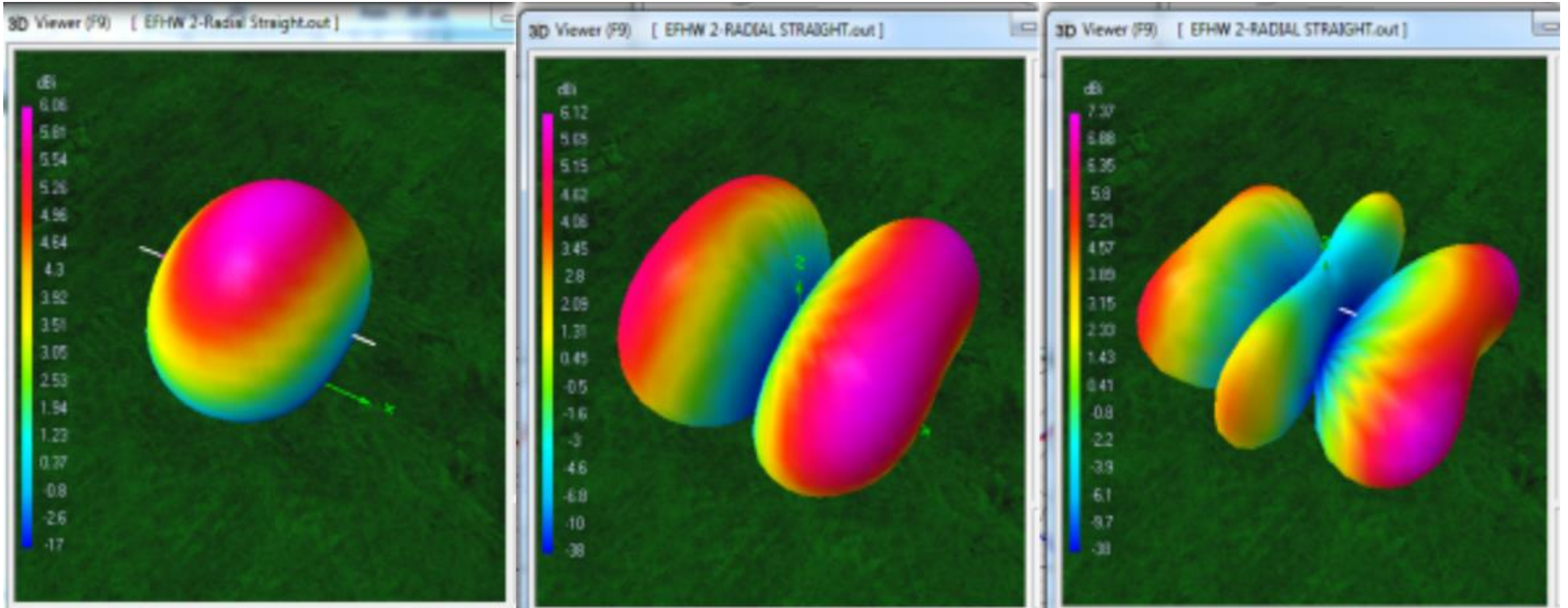

20 m
4 lobes

4th Harmonic
8.92 dBi at 70°

15m
6 lobes

6th Harmonic
10.5 dBi at 75°

10m
8 lobes

8th Harmonic
10.2 dBi at 80°

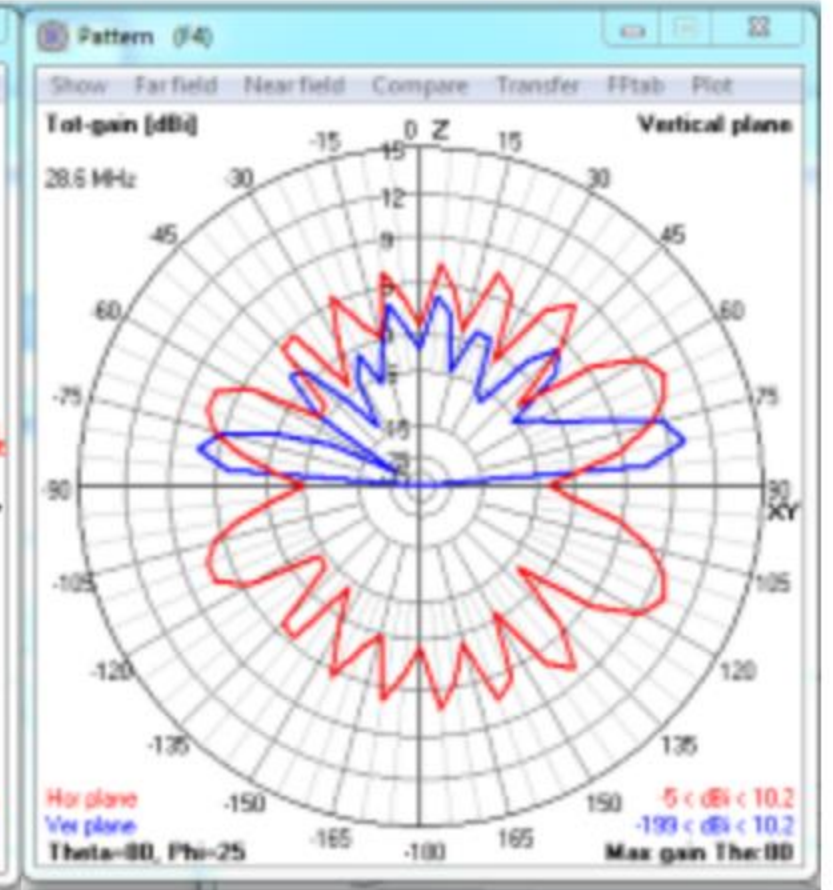
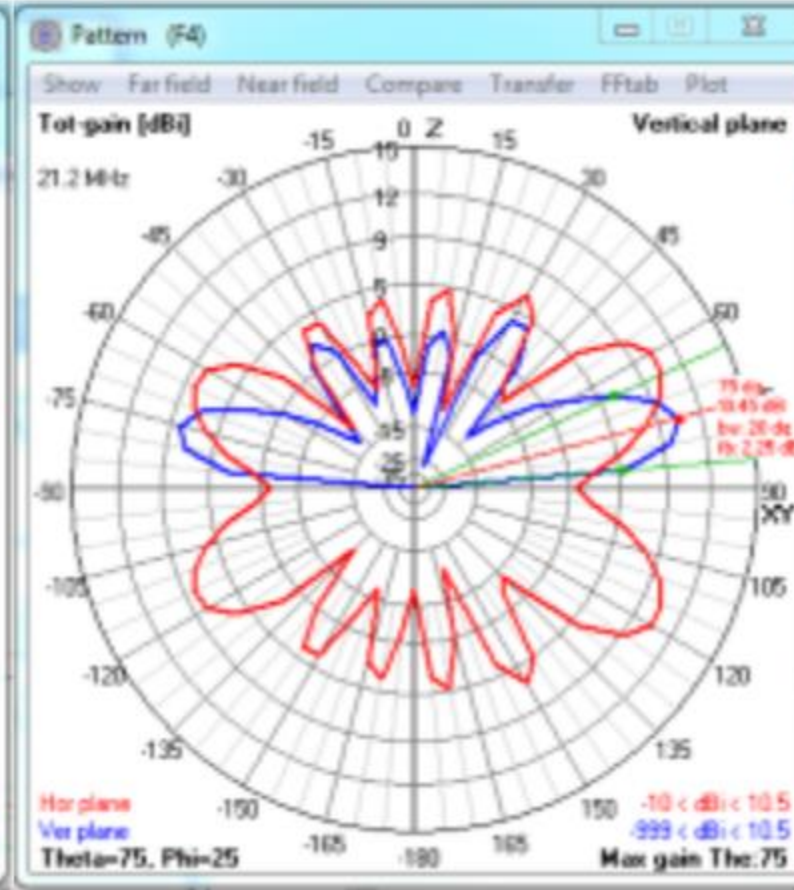
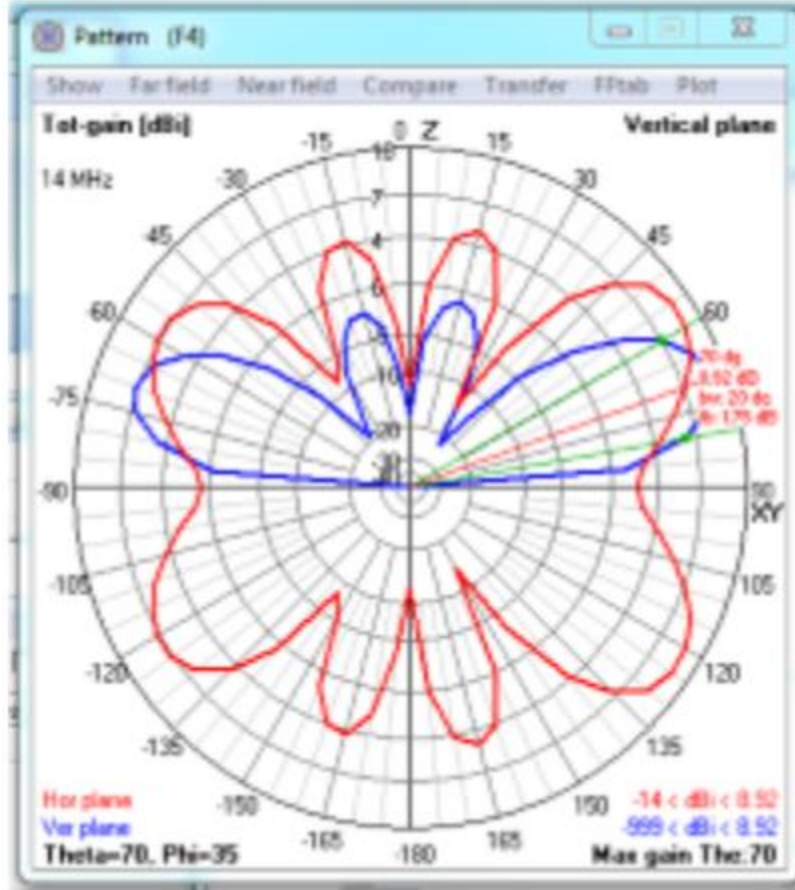

20 m 4th Harmonic
4 lobes 8.92 dBi at 70°

15m 6th Harmonic
6 lobes 10.5 dBi at 75°

10m 8th Harmonic
8 lobes 10.2 dBi at 80°

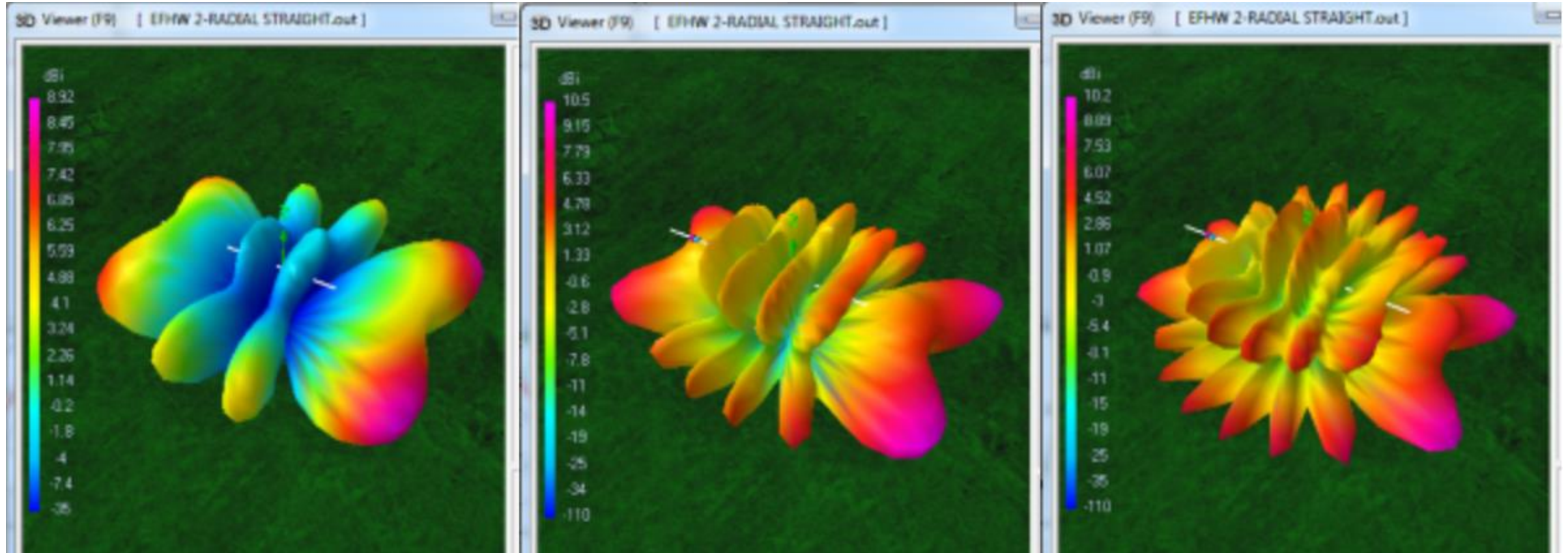

Take aways for end fed wires

- High impedance will require a matching system. For EFHW use 49:1 UNUN, for random wire use 9:1 UNUN, for Zepp, use 50 Ω match on ladder line.
- You will want to isolate the common mode current. It works best to be 0.05λ from the transformer
- The coax will act as a counterpoise. Experiment with different lengths
- Use a line isolator at the shack entrance as a common mode choke to keep the RF out of the shack.
- Higher power requires correct sizing for the transformer for power dissipation.
- Random wire works great for QRP for SOTA/POTA – especially with a good ATU or match box (e.g., like in a KX-2).

ARRL has an EFHW Kit on sale for \$69.95



END-FED HALF-WAVE ANTENNA KIT

ARRL has partnered with HF Kits to bring you this easy-to-build 4-band antenna kit: an end-fed half-wave (EFHW) antenna. We built it in the ARRL Lab, set it up outside, trimmed the wire for the lowest SWR, and got it on the air. Now it's your turn!

ITEM DETAILS:

The advantage of an EFHW is the ease of construction, it's versatility in a variety of installation configurations (sloping, horizontal, L, etc.), no tuner is needed, and this one works on 4 bands: 10, 15, 20, and 40 meters. We chose a 250-watt rated antenna so you can comfortably transmit the full output power from many off-the-shelf HF transceivers (typically around 100 watts).

Building the kit is easy. You'll drill, fasten, and solder (a small amount). Most everything goes into the included weather-proof box. Admire, then deploy!